

ROHS COMPLIANCE

DATE	DESCRIPTION	REV
12.12.04	NEW RELEASE	A

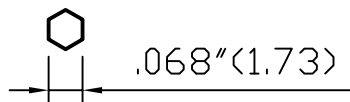

Recommended Crimped Dimensions for Center Pin

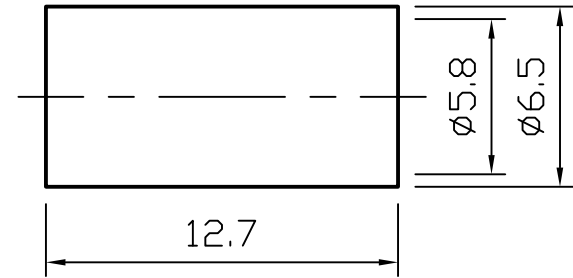
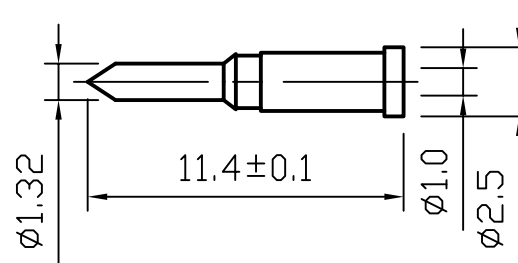
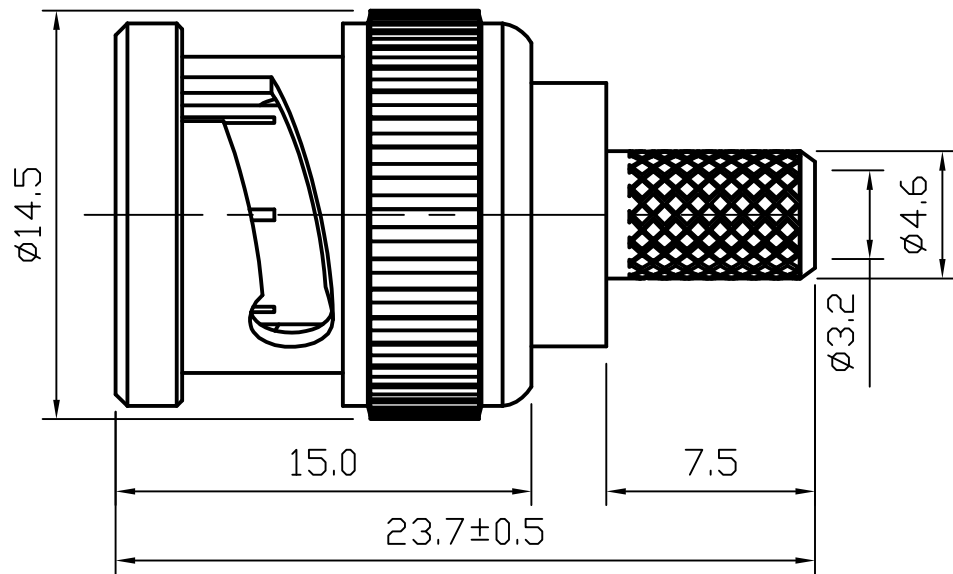
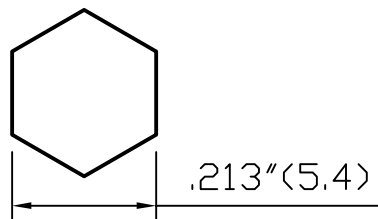

Recommended Crimped Dimensions for Ferrule

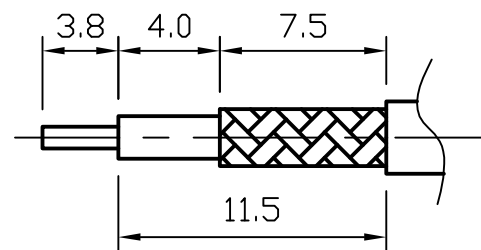

Recommended Cable Stripping Dimensions

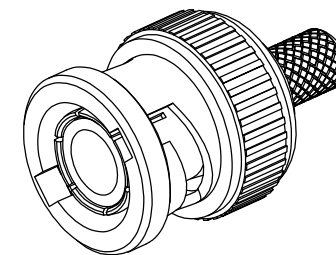

9	PIN	1	BRASS	GOLD	
8	RING	1	BRASS	NICKEL	
7	INSULATOR	1	POM	WHITE	
6	GASKET	1	PVC	RED	
5	WASHER	1	STEEL	NICKEL	
4	SPRING	1	SK-5	NICKEL	
3	WASHER	1	STEEL	NICKEL	
2	BODY	1	BRASS	NICKEL	
1	SHELL	1	BRASS	NICKEL	
NO	Description	Q'ty	Material	Finish	Part Number

UNLESS OTHERWISE SPECIFIED
 1. REMOVE ALL BURRS.
 2. BREAK ALL CONNERS & EDGES CO.15 MAX.
 3. CHAMFER 1ST & LAST THREADS 45°.
 4. DIAMETERS ON COMMON CENTERS.
 TO BE CONCENTRIC WITHIN 0.01 T.I.R.
 5. ALL DIMENSIONS ARE AFTER PLATING.

MAJOR DIMENSIONS
 UNLESS OTHERWISE NOTED TOLERANCES
 0.5-6=±0.2
 6-30=±0.4
 30-120=±0.6
 ANGLES=±5°

APPROVED BY
 CHECKED BY
 DRAWING BY
Sheng
 DATE 2012/12/04

DRAWING NO
B-001-1DGN-223U
 TITLE
BNC MALE CRIMP FOR RG223U
 REV. A

WEIJE ELECTRONICS CO., LTD

DO NOT SCALE DRAWING