

ROHS COMPLIANCE

DATE	DESCRIPTION	REV
13.02.20	NEW RELEASE	A
13.06.03	The design of the pin is modified	B

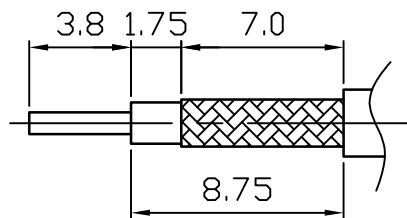

Recommended Cable Stripping Dimensions

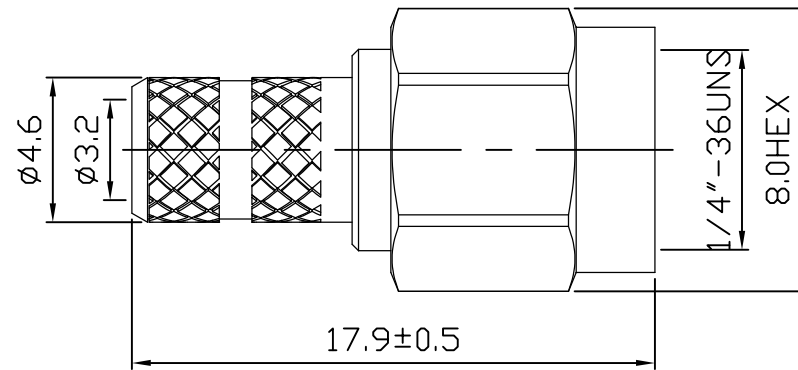
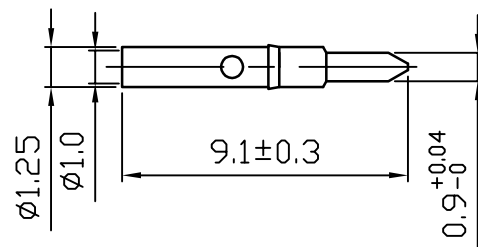
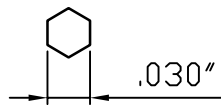

Recommended Crimped Dimensions For Center Pin

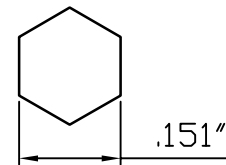

Recommended Crimped Dimensions For Ferrule

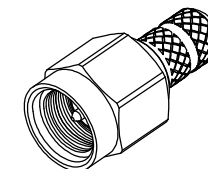

DO NOT SCALE DRAWING

7	GASKET	1	RUBBER	RED	
6	C-RING	1	BERYLIUM	NONE	
5	RING	1	BRASS	NICKEL	
4	INSULATOR	1	PTFE	WHITE	
3	PIN	1	BRASS	GOLD	
2	BODY	1	BRASS	NICKEL	
1	SHELL	1	BRASS	NICKEL	
NO	Description	Q'ty	Material	Finish	Part Number

UNLESS OTHERWISE SPECIFIED  
 1. REMOVE ALL BURRS.  
 2. BREAK ALL CONNERS & EDGES CO.15 MAX.  
 3. CHAMFER 1ST & LAST THREADS 45°.  
 4. DIAMETERS ON COMMON CENTERS.  
 TO BE CONCENTRIC WITHIN 0.01 T. I. R.  
 5. ALL DIMENSIONS ARE AFTER PLATING.

MAJOR DIMENSIONS  
 UNLESS OTHERWISE NOTED TOLERANCES  
 0.5-6=±0.2  
 6-30=±0.4  
 30-120=±0.6  
 ANGLES=±5°

APPROVED BY  
 CHECKED BY  
 DRAWING BY  
*Sheng*  
 DATE  
 2013/06/03

DRAWING NO  
**S-001-1TGN-A**  
 TITLE  
**SMA MALE CRIMP FOR RG/58U**  
 REV.  
**A**  
 **WEIJE ELECTRONICSO CO., LTD**

8 7 6 5 4 3 2 1