

ROHS COMPLIANCE

DATE	DESCRIPTION	REV
13.12.30	NEW RELEASE	A

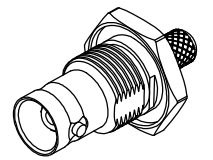
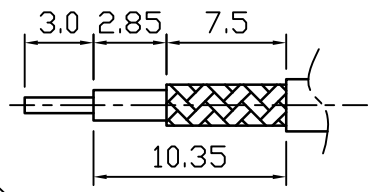
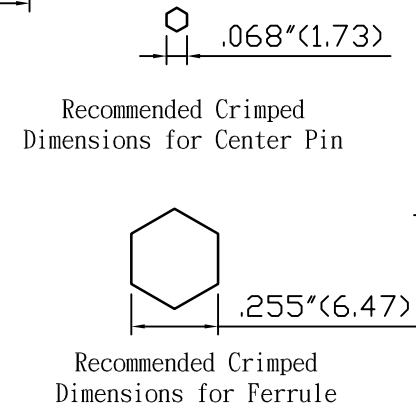
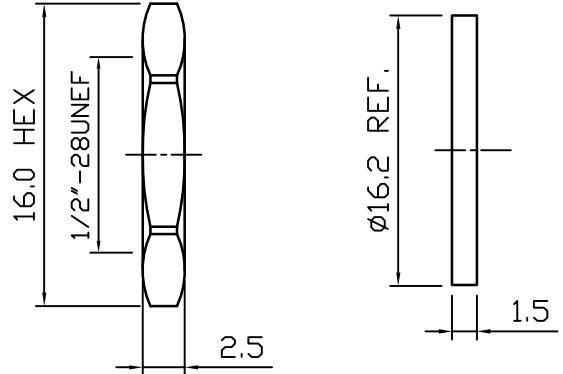
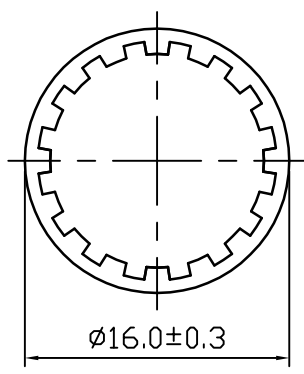
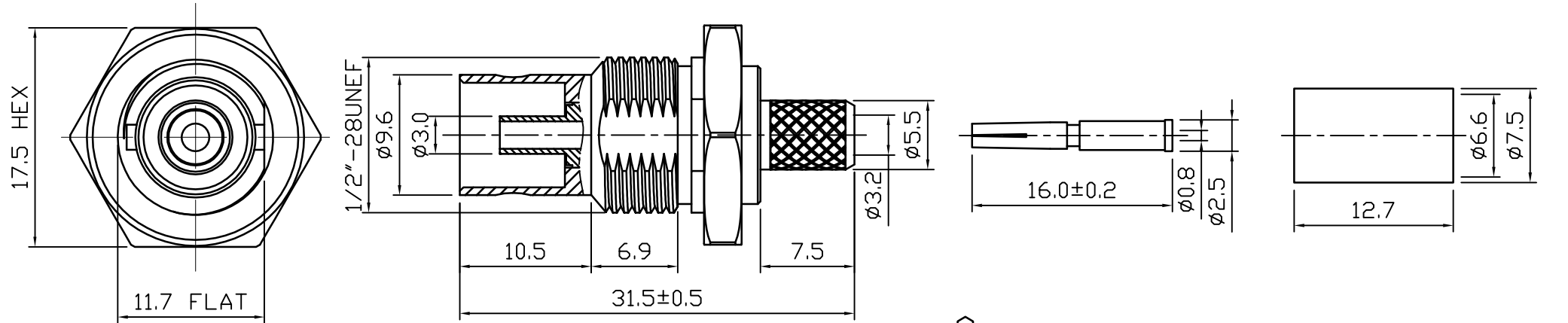

DO NOT SCALE DRAWING

7	RING	1	BRASS	NICKEL	
6	WASHER	1	STEEL	NICKEL	
5	NUT	1	BRASS	NICKEL	
4	GASKET	1	PVC	ORANGE	
3	INSULATOR	1	POM	WHITE	
2	PIN	1	BRASS	GOLD	
1	BODY	2	BRASS	NICKEL	
NO	Description	Q'ty	Material	Finish	Part Number

UNLESS OTHERWISE SPECIFIED  
 1. REMOVE ALL BURRS.  
 2. BREAK ALL CONNERS & EDGES CO.15 MAX.  
 3. CHAMFER 1ST & LAST THREADS 45°.  
 4. DIAMETERS ON COMMON CENTERS.  
 TO BE CONCENTRIC WITHIN 0.01 T. I. R.  
 5. ALL DIMENSIONS ARE AFTER PLATING.

MAJOR DIMENSIONS  
 UNLESS OTHERWISE NOTED TOLERANCES  
 0.5-6=±0.2  
 6-30=±0.4  
 30-120=±0.6  
 ANGLES=±5°

APPROVED BY  
 CHECKED BY  
 DRAWING BY  
*Sheng*  
 DATE 2013/12/30

DRAWING NO  
**B-023-1DGN-B**  
 TITLE  
 BNC JACK CRIMP FOR RG59/U(75ohm)  
 REV. A  
 WEIJE ELECTROICS CO., LTD

8 7 6 5 4 3 2 1